



DoseTech DMS
Detergent Management System

Table of Contents

Introduction	2	Squeeze Tube Replacement	14
System Control Panel	2	Replacement Parts	15
Specifications	3	Parts Diagram	16
Accessory Kit Checklist	3	Wiring Diagram	17
Installation Procedures	4	EC - Declaration of Conformity	18
Programming	6	Mounting Template	22
Operations	11	Warranty Information	24
Troubleshooting	12	Knight Locations	24

Introduction

The DoseTech DMS detergent management system is a dispensing system used to transfer precise amounts of pre-soak chemicals into a pre-wash sink. This chemical dosing system uses an electronically controlled peristaltic pump to dispense detergent. Multiple dosing levels can be programmed to meet specific soil conditions for full and half sink levels providing optimal cleaning results prior to automated decontamination steps. The system is comprised of main control/pump unit, water temperature monitor, chemical supply line with weight and filter, chemical discharge line with check valve and attaching hardware. System is not for use in potentially explosive environments.

Safety Symbols

Listed below are explanations of the safety symbols that appear either on the unit, in the instruction manual, or both. Please familiarize yourself with the meaning of each symbol.



GENERAL CAUTION: This symbol indicates a general safety caution.



SHOCK HAZARD: This symbol indicates that hazardous voltages are inside the enclosure.



READ MANUAL: This symbol indicates to read the manual for important instructions and procedures related to safety.

Safety Precautions



CAUTION: Wear protective clothing and eye wear whenever operating this system.



CAUTION: Wear protective clothing and eye wear when dispensing chemicals. Observe safe handling instructions (MSDS) provided on chemical container or as supplied by chemical manufacturer.



CAUTION: To avoid severe or fatal shock, physical injury, always disconnect main power when servicing the unit.

- System is for indoor use only
- Do not submerge or place in direct path of spray/moisture
- System operates on safe 24 VDC power
- Only approved, factory authorized technicians to service unit

DoseTech DMS Specifications

Dimensions	6" H x 7" W x 6-1/4" D 15.2 cm x 17.8 cm x 15.9 cm
Case Rating	IP-XO
Dosing Pump Flow Rate	250 ml/min.
Power Supply / Voltage	Wall Mount Type, In: 110-240 VAC 1A 50-60 Hz Out: 24 VDC 1.7A
Chemical Compatibility—Dose Pump	Industry standard enzymatic and other detergents.
Unit Weight	4.3 lbs, 1.95 kg
Temperature Probe	Max temperature—221° F, 105° C



DoseTech DMS Accessory Kit Check List

Item No.	Part Number	Qty.	Description	Check Box*
1	7020120	1	Suction Cup, 1" OD Vinyl	<input type="checkbox"/>
2	7901200	1	Check Valve, ½ PDI Cracking Pressure, ¼ x ¼ Barb, Viton	<input type="checkbox"/>
3	0300121	10	Cable Ties	<input type="checkbox"/>
4	0200009	4	Cable Tie Mounts	<input type="checkbox"/>
5	7020152	4	Clamp, Nylon, Snap—.46 Snap	<input type="checkbox"/>
6	0300519	1	Ceramic tube Weight, 3/8 Supply Tube	<input type="checkbox"/>
7	2201225-EP	1	Umbrella Foot Valve	<input type="checkbox"/>
8	7025841	180 Inches 15 Ft.	Tube, T-38 Vinyl, ¼ ID x 3/8 OD (bulk)	<input type="checkbox"/>
9	7600121	3	Mounting Screws and Anchors (sets of two)	<input type="checkbox"/>
10	1600266	1	Control Box Cover (Remote Wall Bracket)	<input type="checkbox"/>

*If items are missing from your kit, please contact Knight customer service immediately: 1-800-854-3764. The serial number on your dispenser will be required at the time of the call.

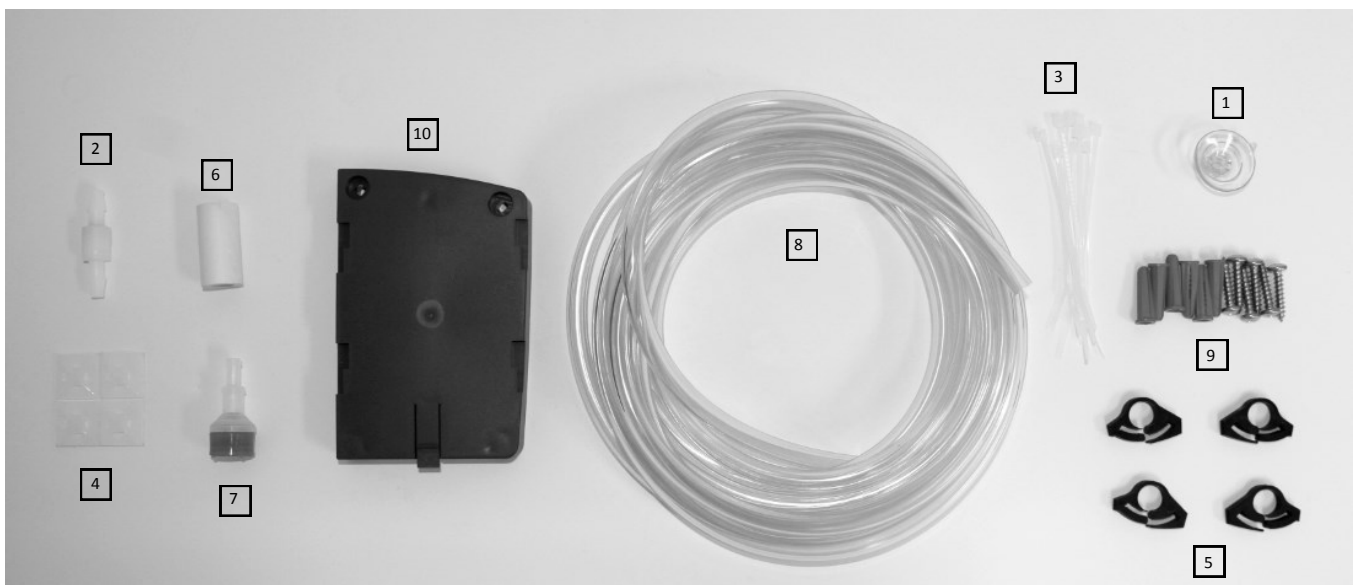

Installation Procedures

1. Tools you will need: drill and drill bit, Phillips screw driver, needle nose pliers, wire cutters, or something similar to cut tubing and cable ties.
2. To begin the installation of the DoseTech DMS, remove all of the accessories from the included accessory kit.
3. Remove the faceplate from the DoseTech DMS by removing the screw and pushing up. Attach the detergent suction tube to the pump as shown in Fig. 1. Use a black nylon clamp to secure the tube. Replace the faceplate.
4. If you have the time-based option, connect the dispenser discharge tube to the discharge squeeze tube as shown in Fig 2. Tip: If you soak the end of the tube in hot water for 30 seconds, it will slide on with less resistance. Use a black nylon clamp to secure the tube.
5. If you have the flow meter option, connect the dispenser discharge tube to the flow meter as shown in Fig. 3. Use a black nylon clamp to secure the tube. Note: Before connecting the dispenser discharge tube to the flow meter, run the tube through the black nylon clamp so that it will be easier to clamp after the tube has been connected to the flow meter. Tip: If you soak the end of the tube in hot water for 30 seconds, it will slide on with less resistance.
6. Select a place to mount the dispenser. Ensure that it will be mounted within 6' (1.8m) of a 115 VAC outlet. It is important to keep the cord above the sink level. It is not recommended to use an extension cord. Verify the dispenser will be mounted within 4' (1.2m) above the floor, and no more than 10' (3m) total distance from the detergent. Note: It is important to mount the dispenser on a hard, flat surface, that is level. See Fig. 4.
7. Cut out the template on page 22 for mounting the dispenser. Place the template against the surface that the dispenser will be mounted to. Use the horizontal lines on the template to make sure the template is level. Tape the template to the wall to secure it in place. Pierce the template with a sharp pencil to mark where the anchors and screws will go. Remove the template and pre-drill the holes for the anchors. Insert the anchors and the top two screws. Make sure to leave enough space between the anchors and the head of the tightened screws for the key holes on the dispenser to fit. Mount the dispenser by aligning the key holes with the screws and dropping the dispenser in place. Make sure not to put too much pressure on the dispenser. Secure the dispenser with the bottom two screws.
8. Route the detergent suction tube to the detergent container. Trim the detergent suction tube to the proper length after verifying that there is enough tube to reach to the bottom of the detergent container.
9. Drill or cut a 3/8" hole into the bottle cap of the detergent container and insert the detergent suction tube through the hole. Slide the ceramic tube weight and umbrella foot valve onto the detergent suction tube. See Fig 5. Place the cap on the detergent. Push the suction tube to the bottom of the container. Be sure there are no kinks in the tube or obstructions that would impede the flow of detergent to the pump.
10. Use the cable tie mounts and cable ties to secure the detergent suction tube to the wall that leads to the dispensing unit. Trim the excess plastic from the cable ties once the detergent suction tube has been secured. See Fig. 6.

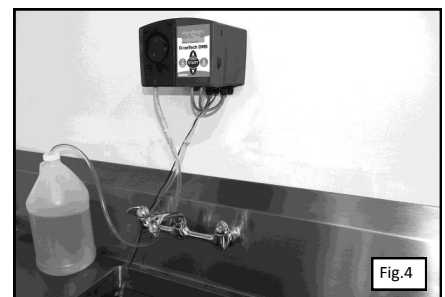
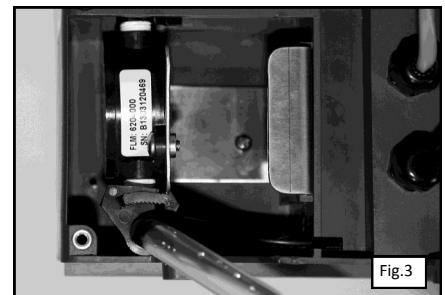
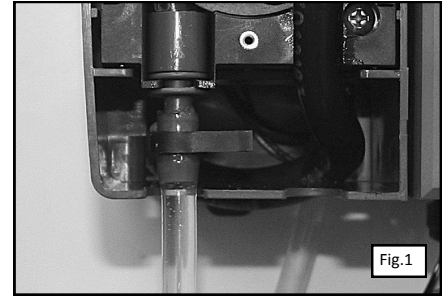

11. Route the dispenser discharge tube and temperature probe to the back of the sink where it will be mounted just above the bottom (1-3"), depending on the total volume of the sink fill. Trim the excess tubing from the dispenser discharge tube once you have verified the length. Attach the check valve to the end of the dispenser discharge tube. Make sure that the arrow points in the direction of the flow. Use the vinyl suction cup and cable ties to secure the discharge tube and temperature probe to the inside of the sink. See Fig. 7. Use additional cable ties to secure the dispenser discharge tube to the temperature probe to keep them together as they go up to the dispenser.
12. Route the power supply cable to the outlet and secure with the cable ties. If the detergent suction tube and power supply are located on the same side, secure them together for a cleaner installation.
13. If mounting the remote control away from the dispenser, you will need to loosen the strain reliefs on the bottom of the dispenser, open the control cover, cut the zip tie, and pull the cables to the length needed (up to 12 feet). Do not pull on the remote control unit to pull the cables out. Roll up the left over cables and place them back into the dispenser. Close the control cover and tighten the strain reliefs. See Fig. 8.
14. Measure the distance between the key holes on the remote wall bracket and pre-drill the holes for the anchors in the wall. Insert the anchors. Attach the remote wall bracket with the screws to the anchors. Mount the remote to the remote wall bracket by sliding it down onto the bracket until it locks into place. See Fig. 9.
15. If you will be using the sink top mounting kit, rather than wall mounting the dispenser, attach the four hex stand off screws to the bottom of the dispenser. Attach the stand base to the hex stand off screws with the four pan head screws. See Fig 10.
16. If you will be using the foot pedal control (Fig. 11) for hands free dosing, loosen the strain relief on the bottom of the dispenser, insert the wires from the foot pedal control, remove the remote and open the control cover. Attach the white wire to the REMOTE START terminal on the barrier strip and the black wire to the GND terminal on the barrier strip. See Fig. 12. Tighten the strain relief, close the control cover and attach the remote.

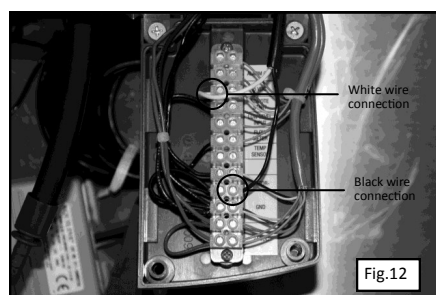
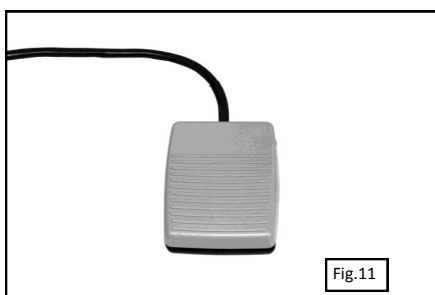
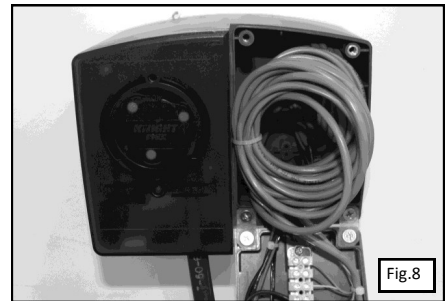
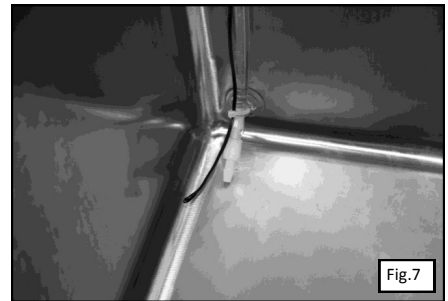
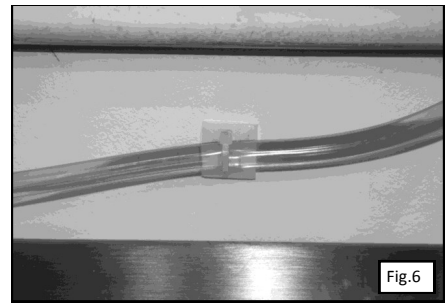

Programming DoseTechDMS

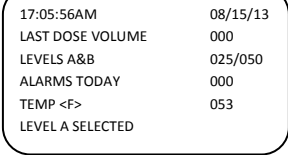
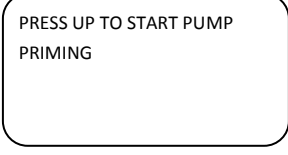
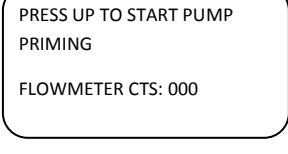
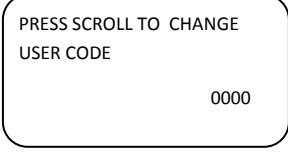
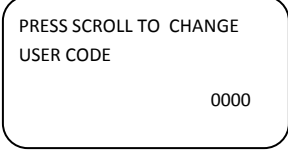
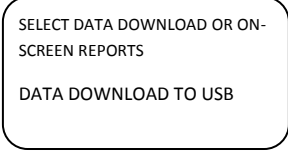
	Description of Screen	Display
1.	<p>Power on the unit.</p> <p>For about 2 seconds you will see the screen to the right.</p> <p>If the system is equipped with a USB interface, the current USB version will be displayed.</p>	
2.	<p>After about 2 seconds you will see the screen to the right.</p>	
3.	<p>To enter the programming mode, hold down the ENTER button until the display color changes to purple.</p>	
4.	<p>Press the UP button to start/stop priming the detergent. The detergent will fill the detergent suction tube. If the flow meter option is installed, the flow meter counts will be displayed. The detergent will then fill the detergent discharge tube. Once there is a steady flow of detergent out of the detergent discharge tube into the sink, press UP to stop priming.</p> <p>Important:</p> <ol style="list-style-type: none"> 1. Check to make sure the roller block is rotating clockwise. 2. Ensure the FLOWMETER CTS has a numerical value. The range of values will vary. <p>Note: If the flow meter option is installed and auto prime enabled, when the unit is primed it will use calculations from the prime to auto prime the unit when the detergent runs out.</p> <p>Press ENTER to advance to the next screen.</p>	
5.	<p>To access the basic features in the programming mode, you will need a user pass code. To enter a user pass code, use the SCROLL button to scroll between digits and the UP and DOWN buttons to cycle between 0-9. By default, the pass code is set to 0000.</p> <p>Press ENTER to advance to the next screen.</p>	
6.	<p>To change the existing user pass code, use the SCROLL button to scroll between the digits and use the UP and DOWN buttons to cycle between 0-9.</p> <p>Press ENTER to advance to the next screen.</p>	
7.	<p>To view the reports, there are two options:</p> <ol style="list-style-type: none"> 1. Data download (if USB port option is installed, data will be downloaded to USB stick on coming menu options) 2. On-Screen report (data will be displayed directly on LCD) <p>You can choose either option by pressing the SCROLL button. When complete, press ENTER to advance to the next screen.</p>	



Description of Screen		Display
8.	<p>To specify date ranges for a report, press the SCROLL button to scroll between month/date/year, and the UP and DOWN buttons to cycle through the digits.</p> <p>If no report is necessary, scrolling through the dates is not necessary.</p> <p>Press ENTER to advance to the next screen</p>	
9.	<p>To download the report data (USB port option required), insert a USB stick into the USB port and press the UP button. When the download is complete the screen will display "DONE". Remove USB stick. This report can then be viewed with any text editor on a PC. See Fig. 1 on page 13 for an example.</p> <p>Press ENTER to advance to the next screen.</p>	
10.	<p>To access the advanced features in the programming mode, you will need a main pass code. To enter a main pass code, use the SCROLL button to scroll between digits and the UP and DOWN buttons to cycle between 0-9. By default, the pass code is set to 0000.</p> <p>Press ENTER to advance to the next screen.</p>	
11.	<p>To access the advanced features in the programming mode, you will need a main pass code. To enter a main pass code, use the SCROLL button to scroll between digits and the UP and DOWN buttons to cycle between 0-9. By default, the pass code is set to 0000.</p> <p>Press ENTER to advance to the next screen.</p>	
12.	<p>To change the existing main pass code, use the SCROLL button to scroll between the digits and use the UP and DOWN buttons to cycle between 0-9.</p> <p>If you are not changing the code, press ENTER to advance to the next screen.</p>	
13.	<p>To enter a serial number for the dispenser, use the SCROLL button to scroll between digits and the UP and DOWN buttons to cycle between 0-9.</p> <p>Press ENTER to advance to the next screen.</p>	
14.	<p>To set the time and date, press the SCROLL button to scroll between hour/minutes/seconds/meridiem/month/date/year, and the UP and DOWN buttons to cycle through the digits.</p> <p>Note: When entering the time, you must enter it in a 12 hour time format.</p> <p>Press ENTER to advance to the next screen.</p>	
15.	<p>To change the language, use the SCROLL button to toggle between languages.</p> <p>Press ENTER to advance to the next screen.</p>	

Description of Screen		Display
16.	<p>To change the units of measure, use the SCROLL button to toggle between Fahrenheit/Gallons and Celsius/Liter.</p> <p>Press ENTER to advance to the next screen.</p>	<p>PRESS SCROLL TO SELECT WHICH UNITS TO USE FAHRENHEIT/GALLONS</p> <p>PRESS SCROLL TO SELECT WHICH UNITS TO USE CELSIUS/LITER</p>
17.	<p>To choose a low level setting, use the SCROLL button to toggle between N/C and N/O.</p> <p>Important: If you are using a flow meter or the time based feature, you have the choice between N/C (normally closed) and N/O (normally open). The option you choose should match the low level alarm that you are using.</p> <p>Press ENTER to advance to the next screen.</p>	<p>PRESS SCROLL TO SELECT LOW LEVEL STATE LOW LEVEL IS: N/C</p> <p>PRESS SCROLL TO SELECT LOW LEVEL STATE LOW LEVEL IS: N/C</p>
18.	<p>To set the alarm sound on or off, use the SCROLL button toggle to between on and off.</p> <p>Press ENTER to advance to the next screen.</p>	<p>PRESS SCROLL TO TURN ALARM SOUND ON OR OFF ALARM SOUND OFF</p>
19.	<p>To set the dispensing volumes, use the SCROLL button to toggle between volume A and volume B. Use the UP and DOWN buttons to set the numerical value for the amount of detergent you wish to dispense for each volume.</p> <p>Press ENTER to advance to the next screen.</p>	<p>SCROLL TO ENTER VOLUME A 025 ml VOLUME B 050 ml</p>
20.	<p>To set your preferred method of dosing, use the SCROLL button to toggle between Time Based Dosing and Flow Metered Dosing.</p> <p>Press ENTER to advance to the next screen.</p>	<p>PRESS SCROLL TO SELECT DOSE MODE TIME BASED DOSING</p> <p>PRESS SCROLL TO SELECT SCROLL MODE FLOW METERED DOSING</p>
21.	<p>If you selected Flow Metered Dosing for the previous step, you will see the auto prime screen. To set auto prime to on or off, use the SCROLL button to toggle between on and off. Note: This feature is only available with Flow Metered Dosing.</p> <p>Press ENTER to advance to the next screen.</p>	<p>PRESS SCROLL TO TURN AUTO PRIME ON OR OFF AUTO PRIME IS OFF</p>

Description of Screen		Display
21.	To calibrate the pump, place the dispensing tube into a 100-200 milliliter graduated cylinder and press the UP button. The pump will stop on its own after dispensing approximately 100 milliliters of detergent and the display will automatically change to the Entered Captured screen.	PRESS UP TO START PUMP CALIBRATION FOR 100 ml
22.	To enter the volume captured by the graduated cylinder, use the SCROLL button to scroll between digits and the UP and DOWN buttons to cycle between 0-9. Press ENTER to advance to the next screen.	ENTER CAPTURED VOLUME IN ML VOLUME = 102 ml
23.	The flow rate for the pump is displayed. Press ENTER to advance to the next screen.	FLOWRATE FOR THE PUMP IN ML/MN IS: FLOWRATE = 240
24.	To check for proper calibration, repeat the pump calibration steps. The target calibration volume is 100 mls +/- 3 mls. Once you are satisfied with the calibration of the pump, press ENTER to advance to the next screen.	PRESS UP TO START PUMP CALIBRATION FOR 100 ml
25.	To set a temperature range, use the SCROLL button to toggle between the min range and the max range. Use the UP and DOWN buttons to select a numerical value. Once this range is set, you will have to ensure the sink is filled with water to meet your minimum setting, but not exceed your maximum. Any variation below the minimum or above the maximum will set the alarm off. Press ENTER to advance to the next screen.	PRESS SCROLL TO ENTER TEMP RANGE MIN TEMP. 100F MAX TEMP. 120F
26.	To calibrate the temperature, place a thermometer in the sink filled with water and compare the temperature on the thermometer and the display of the dispenser. If they are not equal, use the UP and DOWN buttons to enter the correct temperature. Press ENTER to advance to the next screen.	PRESS UP/DOWN TO ENTER CALIBRATION TEMPERATURE TEMP <F> 078
27.	To turn the temperature hold on or off, use the SCROLL button to toggle between on and off. If you have mandatory temperature requirements, you should leave the temperature hold on as this will prevent dosing if the temperature is not within range. If no temperature requirements are mandatory, select off and the temperature control will remain off. Press ENTER to advance to the next screen.	PRESS SCROLL TO TURN TEMPERATURE HOLD ON OR OFF TEMP. HOLD IS ON

	Description of Screen	Display
28.	<p>To clear the usage report data memory, press the SCROLL button and DOWN button at the same time. A second screen will appear asking you "Are you sure?" Press the SCROLL button and DOWN button at the same time to confirm. The screen will display "Done".</p> <p>Press ENTER to advance to the next screen.</p>	<p>PRESS SCROLL AND DOWN TO CLEAR USAGE DATA MEMORY</p>
29.	<p>To enter a hospital name, use the SCROLL button to toggle to between characters, and use the UP and DOWN buttons to select A-Z.</p> <p>Press ENTER to advance to the next screen.</p>	<p>ENTER HOSPITAL NAME</p>
30.	<p>To enter a department name, use the SCROLL button to toggle between characters, and use the UP and DOWN buttons to select A-Z.</p> <p>Press ENTER to advance to the next screen.</p>	<p>ENTER DEPARTMENT NAME</p>
31.	<p>To enter a detergent/product name, use the SCROLL button to toggle between character, and use the UP and DOWN buttons to select A-Z.</p> <p>Press ENTER to advance to the next screen.</p>	<p>ENTER PRODUCT NAME</p>
32.	<p>To upload a customized graphic which will be displayed when the dispenser has been in idle, insert USB stick and press UP to upload. Once upload is complete the screen will display "Done".</p> <p>Note: Graphic needs to be 128 x 64 pixels in size, black and white, in a .bmp format, and saved with the filename: image.bmp.</p> <p>Press ENTER to advance to the next screen.</p>	<p>PRESS UP TO START GRAPHICS UPLOAD</p>
33.	<p>To change the time for the graphic to display, use the UP and DOWN buttons to cycle between 0-9. Enter the timeout in minutes.</p> <p>Press Enter to advance to next screen.</p>	<p>PRESS UP/DOWN TO ENTER GRAPHICS</p> <p>TIMEOUT IN MINUTES: 001</p>
34.	<p>To set the soak times for preset A and preset B, use the SCROLL button to toggle between A and preset B, and use the UP and DOWN buttons to select a numerical value.</p> <p>Press ENTER to loop back to the first menu screen.</p>	<p>PRESS SCROLL TO ENTER SOAK TIMER A&B</p> <p>A <min:sec> 00:20</p> <p>B <min:sec> 00:30</p>
35.	<p>Press and hold ENTER button to save all of your programming changes. The standard blue screen will appear notifying you that you have left the programming mode.</p>	<p>17:05:56AM 08/15/13</p> <p>LAST DOSE VOLUME 000</p> <p>LEVELS A&B 025/050</p> <p>ALARMS TODAY 000</p> <p>TEMP <F> 053</p> <p>LEVEL A SELECTED</p>

Operating DoseTech DMS

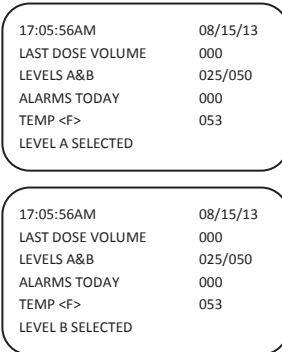
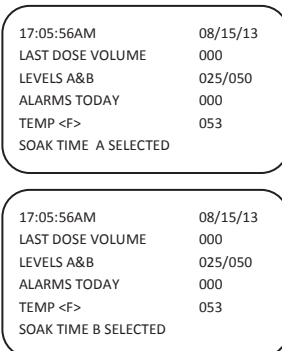
	Description of Screen	Display
1.	<p>Power on the unit.</p> <p>For about 2 seconds you will see the screen to the right.</p> <p>If the system is equipped with a USB interface, the current USB version will be displayed.</p>	
2.	<p>If the dispenser has been idle for an extended period of time, the default is an image as shown to the right. The image is specific to Knight's product logo unless you have uploaded your own graphic. To uploaded your own graphic, please refer to step 32 in the programming menu.</p> <p>To exit the idle mode, press the START button.</p>	
3.	<p>Next you will see the top screen to the right. You are currently in the dispensing runtime mode. If the TEMP (F) is flashing, this means that the temperature is out of range. See troubleshooting section for solutions if needed.</p> <p>Level A is the default selection. To choose between level A or level B, press A or B button.</p> <p>Press START to begin dispensing for the selected level. The dispenser will begin pumping in either time-based mode or flow meter based mode the amount programmed in step 19 of the programming procedures.</p>	
4.	<p>To change from the dispensing runtime screen to the soak timer runtime screen, press the UP or DOWN button to toggle between the dispensing runtime screen and the soak timer runtime screen.</p> <p>To choose between soak time A and soak time B, press A or B button.</p> <p>Press START to begin the countdown of the selected soak timer. The display will show a countdown from the time programmed in step 34 of the programming procedures.</p>	

DoseTech DMS Runtime Alerts

Description of Screen	Display
If TEMP is flashing on the blue runtime screen, the temperature of the water is not within the predefined range. Adjust the water temperature before dispensing.	<pre> 17:05:56AM 08/15/13 LAST DOSE VOLUME 000 LEVELS A&B 025/050 ALARMS TODAY 000 TEMP <F> 053 LEVEL A SELECTED </pre>
If TEMP OUT OF RANGE is displayed in green, the temperature of the water is not within the predefined range.	<pre> TEMP OUT OF RANGE </pre>
If the Chemical empty! Alert is displayed in red, the detergent container is empty and needs to be replaced and the unit re-primed. Replace the detergent container then press START to begin automatic re-printing.	<pre> Chemical empty! Replace Chemical Container, then press START button. </pre>

Symptom	Solutions/Cause
Temperature Alarm will not shut off	<ul style="list-style-type: none"> • Adjust temperature range • Adjust water temperature • Replace temperature probe
Dosing Alarm will not shut off	<ul style="list-style-type: none"> • Detergent container empty • Recalibrate detergent pump • Detergent discharge tube worn or broken • Detergent pump squeeze tube worn out or broken
Can't access system menus	<ul style="list-style-type: none"> • Reboot the system • User interface switch inoperable • Incorrect pass code—contact Knight for temporary pass code
Pump tube broken or worn	<ul style="list-style-type: none"> • Replace with factory tube only

DoseTech DMS Report Example

Dispenser S/N:	0			
Report Date:	8/21/2013			
From Date:	8/13/2013			
To Date:	8/21/2013			
Date	Time	Volume	Temperature	Events
8/21/2013	8:42:24AM	50	78	
8/21/2013	8:42:46AM	50	78	
8/21/2013	8:48:38AM	50	77	
8/21/2013	8:49:21AM	24	77	Out of Chem.
8/21/2013	8:49:54AM	20	77	Out of Chem.
8/21/2013	8:50:33AM	23	78	Out of Chem.
8/21/2013	8:50:49AM	50	77	
8/21/2013	8:51:39AM	50	75	Temp. Error
8/21/2013	8:51:59AM	50	75	Temp. Error
8/21/2013	8:52:43AM	50	77	
8/21/2013	8:53:04AM	50	77	
8/21/2013	8:53:26AM	50	77	
Total Usage:	227.3 Gallons			

Fig. 1

Squeeze Tube Replacement Removal and Installation of Front Faceplate



Removal or installation of the pump faceplate for maintenance purposes should **ONLY** be performed by qualified and trained personnel who are considered the Responsible Body for the system.



The facility operators of the system should **NEVER** attempt removal or installation of the pump faceplate and should be made aware of this by the Responsible Body



Access to internal parts are for Responsible Body (i.e. service personnel).

REMOVAL

IMPORTANT: Unplug the unit before removing the faceplate. To remove the faceplate, remove the screw in the center, then slide the faceplate up to pull it away from the pump assembly.

INSTALLATION

To install the faceplate, slide the faceplate on the pump assembly and tighten the screw in the center.

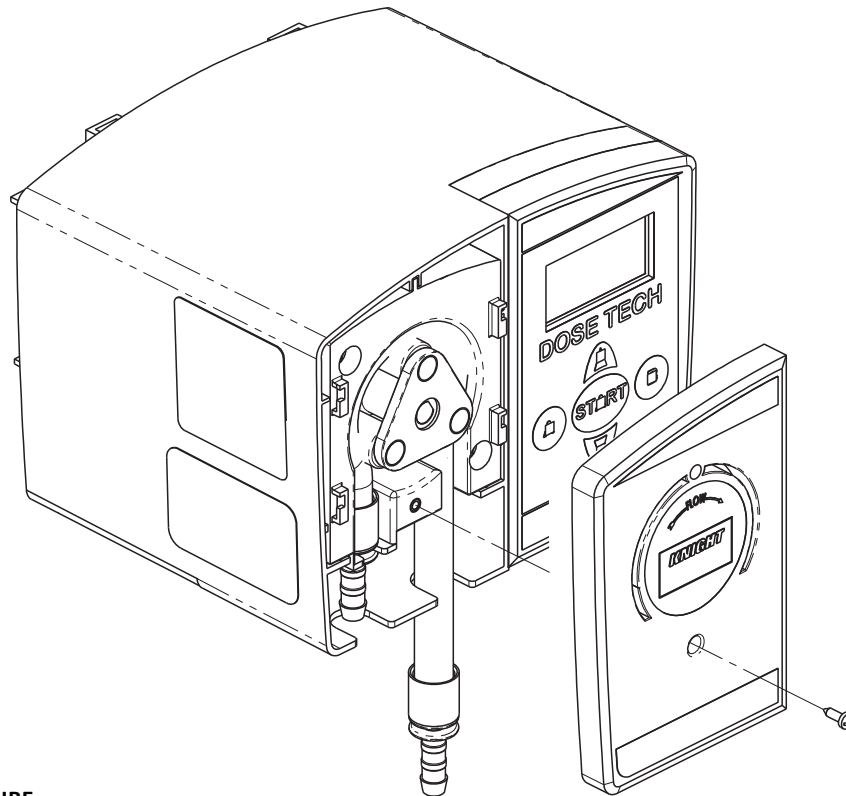

REPLACING THE SQUEEZE TUBE

1. Purge any chemicals from the suction and discharge tubes.
2. Remove the faceplate of the pump per the steps shown above.
3. Disconnect the suction and discharge tubes from pump squeeze tube.
4. Pull the old squeeze tube out of the roller block and remove the barb fittings on each end.
5. Insert the barb fittings into the new squeeze tube and install the new squeeze tube into the roller block.
6. Apply a generous amount of silicone tube lube to the middle third of the tube where the rollers contact it.
7. Re-connect the suction and discharge tubes to the barbs on the new squeeze tube.

DoseTech DMS Replacement Parts

Item No.	Part No.	Qty.	Description
1	7010211-LC	1	Gear Motor w Cap, 100 RPM
2	1600265	1	Body, Pump, 500 Series
3	7320195	2	Phillips Pan Head #10 Screw, Stainless Steel
4	7503450	1	3-Lobe Roller Assembly, Yellow Rollers
5	7018050	1	T-50E, Squeeze Tube, Elastic, 1ft.
6	6049024	1	Retaining Ring for Pump Tube Barb
7	6049025	1	Barb Fitting
8	0600784	2	1/8 MNPT X 1/4 Barb Elbow PVDF Fitting
9	1415000	1	Flow Meter, .4mL, PPS/PPS
10	1900604	2	Phillips Pan Head #6 Screw, Stainless Steel
11	1900460	1	Phillips Pan Head #6 Screw, Hi-Low, Stainless Steel
12	7225689	1	Bracket
13	7020157	1	Clamp, Hose, Nylon, Snap, .468— .531 Dia Black
14	1900664	2	Phillips Pan Head #10 Screw, Stainless Steel
15	1600263	1	Pump Shield (Faceplate)
16	1900576	1	Phillips Pan Head #4 Screw, Stainless Steel
17	1600266	1	Control Box Cover (Remote Wall Bracket)
18	7140817	1	Circuit Board Assembly
19	1414001	1	Temperature Probe
20	1414003	1	Power Supply, 40W, 24VDC, 1.7A
21	6049024	1	Retaining Ring, Barb (Pump Tube Fitting)
22	6049025	1	Barb Fitting (Pump Tube Sleeve)
23	7020152	1	Clamp, Nylon, Snap, .406"
24	7020120	1	Suction Cup, 1" O.D., Vinyl
25	7901200	1	Check Valve, 1/2 PSI Cracking Pressure, 1/4" x 1/4" Barb, Viton
26	7025841	1	Tube, T-38 Vinyl, 1/4" I.D. x 3/8" O.D., 18" (15ft.)
27	2201225-EP	1	Umbrella Foot Valve
28	0300519	1	Ceramic Tube Weight for 3/8" Supply Tube
29	0300121	10	Cable Ties, 3-1/2"
30	0200009	4	Cable Tie Mount
31	1201508	1	Label with Window

REPAIR AND SERVICING

Repairs and servicing of the DoseTech DMS are to be performed by factory authorized technicians or the factory only. Contact your DoseTech DMS supplier for service support.

DoseTech DMS Parts Diagram

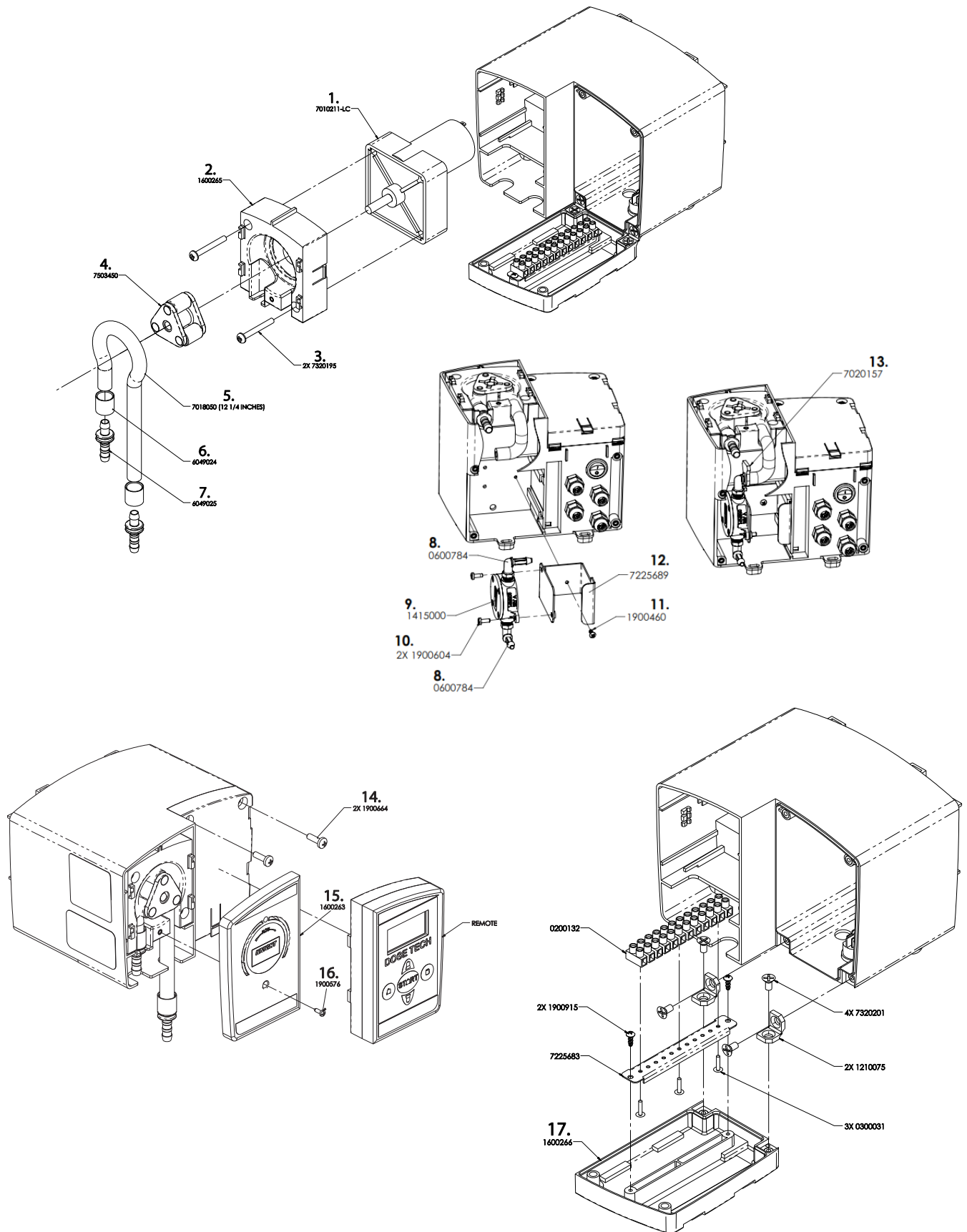

KNIGHT

EC – Declaration of Conformity

We declare that the product listed below, to which this Declaration of Conformity relates, is in conformity with the Standards and other Normative Documents listed below:

Equipment Description: Detergent Management System
Type/Model Number: DoseTech DMS

Low Voltage Directive - 2006/95/EC (and former Directive 73/23/EEC)
Standards to which Conformity is Declared:

Electrical Safety IEC 61010-1 (2nd Ed). EN 61010-1 (2nd Ed) - Safety Requirements for Electrical Equipment for Measurement, Control, and Laboratory Use, Part 1: General Requirements.

For Information: The "Electrical Safety Test" took place at the CSA International, Irvine, CA, U.S.A

Electromagnetic Compatibility
EMC Directive - 2004/108/EC and former Directive 89/336/EEC as amended by 92/31/EEC and 93/68/EEC
Standards to which Conformity is Declared:

EMC Emissions: CISPR 11: Industrial, scientific and medical (ISM) radio-frequency
EN 55011: Equipment - Radio disturbance characteristics - Limits and methods of measurement
EN 61000-3-2: Limits for harmonic current emissions
EN 61000-3-3: Limitation of voltage changes, voltage fluctuations and flicker in public

EMC Immunity: EN 61326-1: 2006 Electrical Equipment Measurement, Control & Laboratory Use (Normal Environment)
EN 61000-4-2: Electrostatic discharge immunity test
EN 61000-4-3: Radiated, radio-frequency, electromagnetic field immunity test
EN 61000-4-4: Electrical fast transient/burst immunity test
EN 61000-4-5: Surge immunity test
EN 61000-4-6: Immunity to conducted disturbances, induced by radiofrequency fields
EN 61000-4-11: Voltage dips, short interruptions and voltage variations immunity test

For Information: The "Electromagnetic Test" took place at the Aegis Labs., Lake Forest, CA, U.S.A

Certification Marking: **CE**

We declared that the equipment specified above conforms to the referenced EU Directives and Harmonized Standards."

Signature:  Date: 09/06/2013
Name: John Chiechi Title: Director of Engineering

DoseTech DMS Mounting Template



FOOTNOTE

The information and specifications included in this publication were in effect at the time of approval for printing. Knight LLC reserves the right, however, to discontinue or change specifications or design at any time without notice and without incurring any obligation whatsoever.

WARRANTY

For complete product terms and conditions scan the QR code below or enter the following URL into your browser:
<http://cfstech.info/t-and-c>

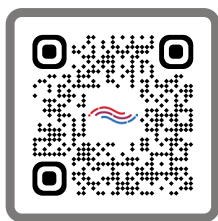

SCAN



KNIGHT LLC is part of the CFS Technologies family of brands.

www.knigthequip.com | cfstech.com

8504 MacArthur Dr., North Little Rock, AR 72118 USA • 501-895-2820 | 800-999-2820

General: sales@cfstech.com | Tech. Assist.: techsupport@cfstech.com